

Model #1: Hoop Rack

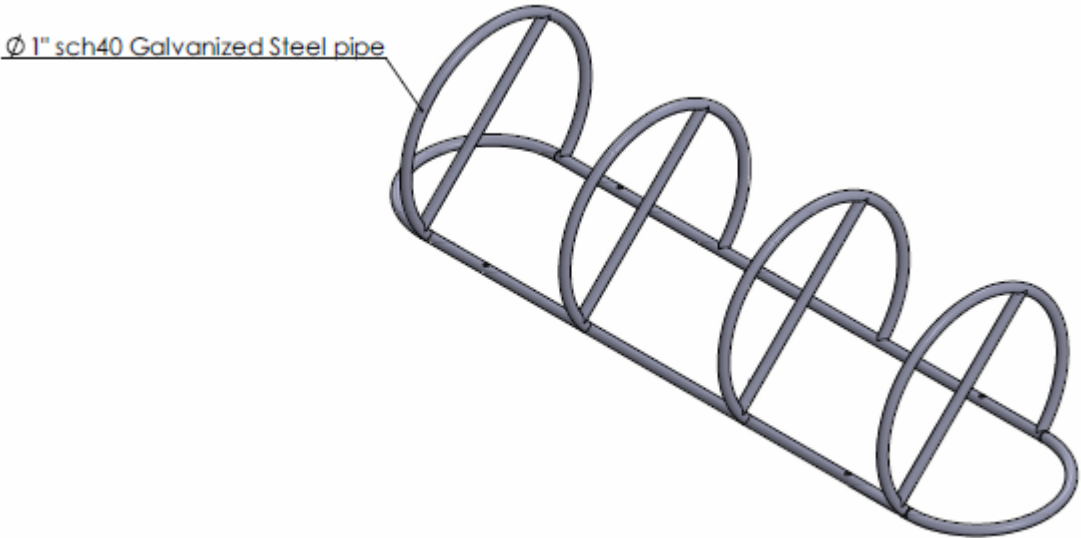

25.5" hoop spacing. 31" hoop diameter. 25" hoop height. 21.5" width at base.

Model #2: Staple Rack

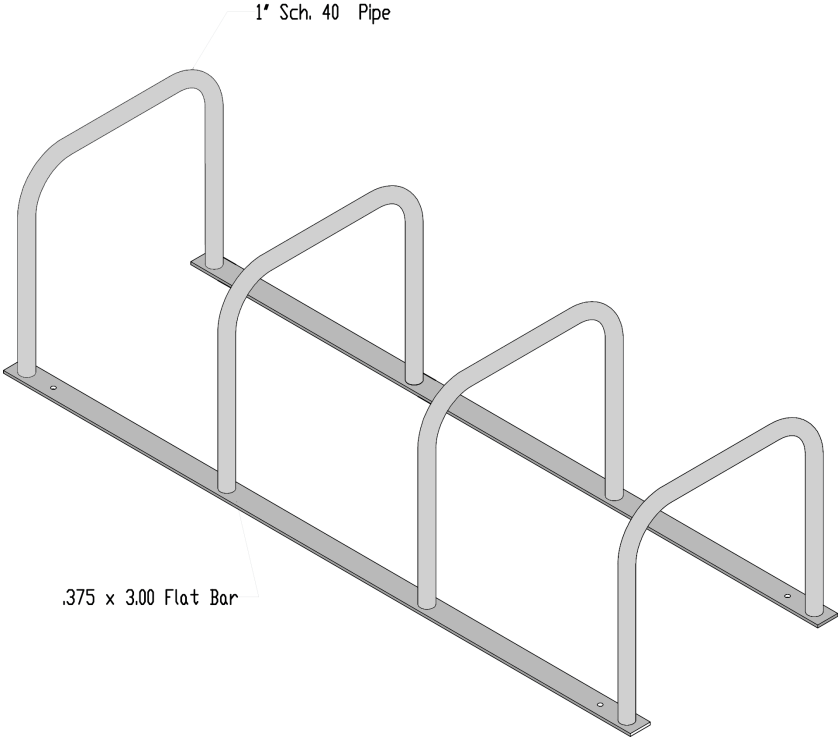

26" staple spacing. 26" staple height. 30" staple width.

Two 4-hoop racks (16 bike capacity) with galvanized finish



Example of non-compliant bike rack: encourages insecure locking (attracting thieves), doesn't support bikes from falling over/being damaged, doesn't fit advertised number of bikes:



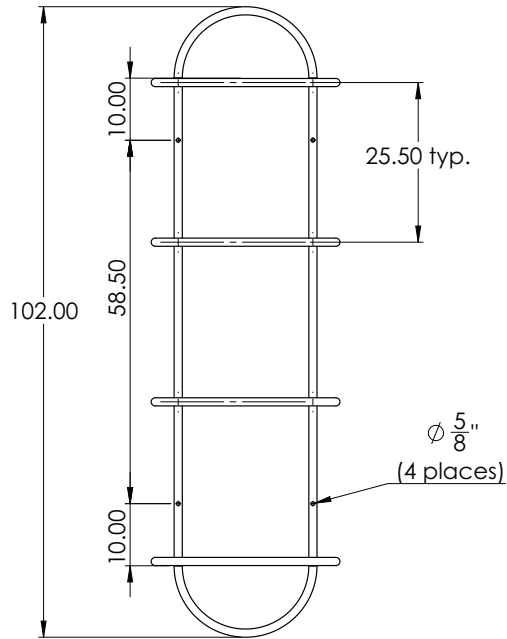

Ø 1" sch40 Galvanized Steel pipe

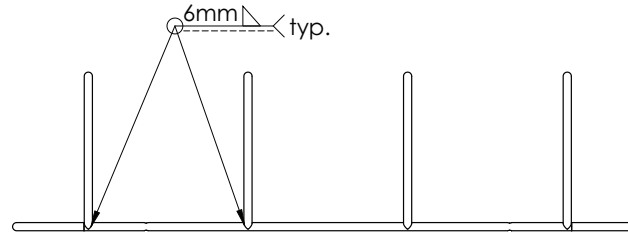
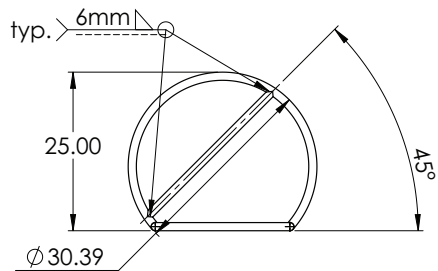
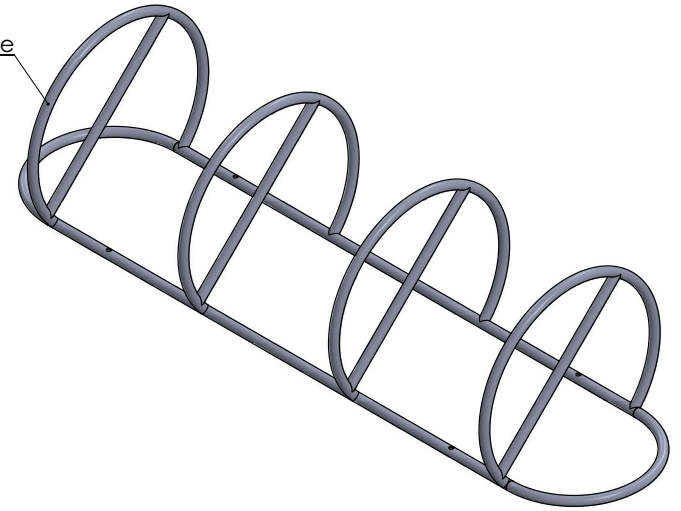

NOTES:
All welds ground and polished smooth.

REV	DESCRIPTION	DATE
REVISION HISTORY		

15011-131 Avenue
Edmonton, AB
T5V 1S9

Ph. (780) 453-7074
Fax. (780) 454-0171

	NAME	DATE (D/M/Y)
DRAWN	JEH	15/08/2012
CHECKED		
ENG APPR.		
MFG APPR.		
Q.A.		

DO NOT SCALE DRAWING
UNLESS OTHERWISE SPECIFIED:
DIMENSIONS ARE IN INCHES
TOLERANCES:
WATER JET: ±0.125 MM
ANGULAR: BEND ±0.5 MM

PROPRIETARY AND CONFIDENTIAL		
THE INFORMATION CONTAINED IN THIS DRAWING IS THE SOLE PROPERTY OF SPECIAL METALS FABRICATING LTD. ANY REPRODUCTION IN PART OR AS A WHOLE WITHOUT THE WRITTEN PERMISSION OF SPECIAL METALS FABRICATING LTD. IS PROHIBITED.		
TITLE: City of Edmonton - multi bike rack overview galv.		
SIZE	DWG. NO.	REV n/a
A		REV. DATE n/a
SCALE: 1:20	WEIGHT:	SHEET 2 OF 2

SHOP

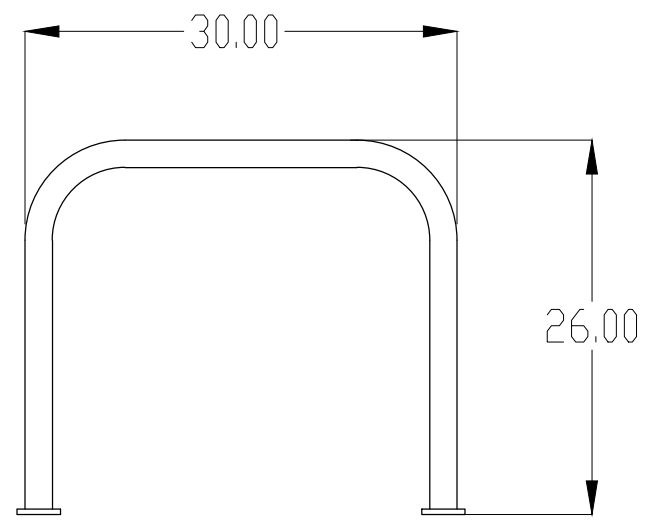
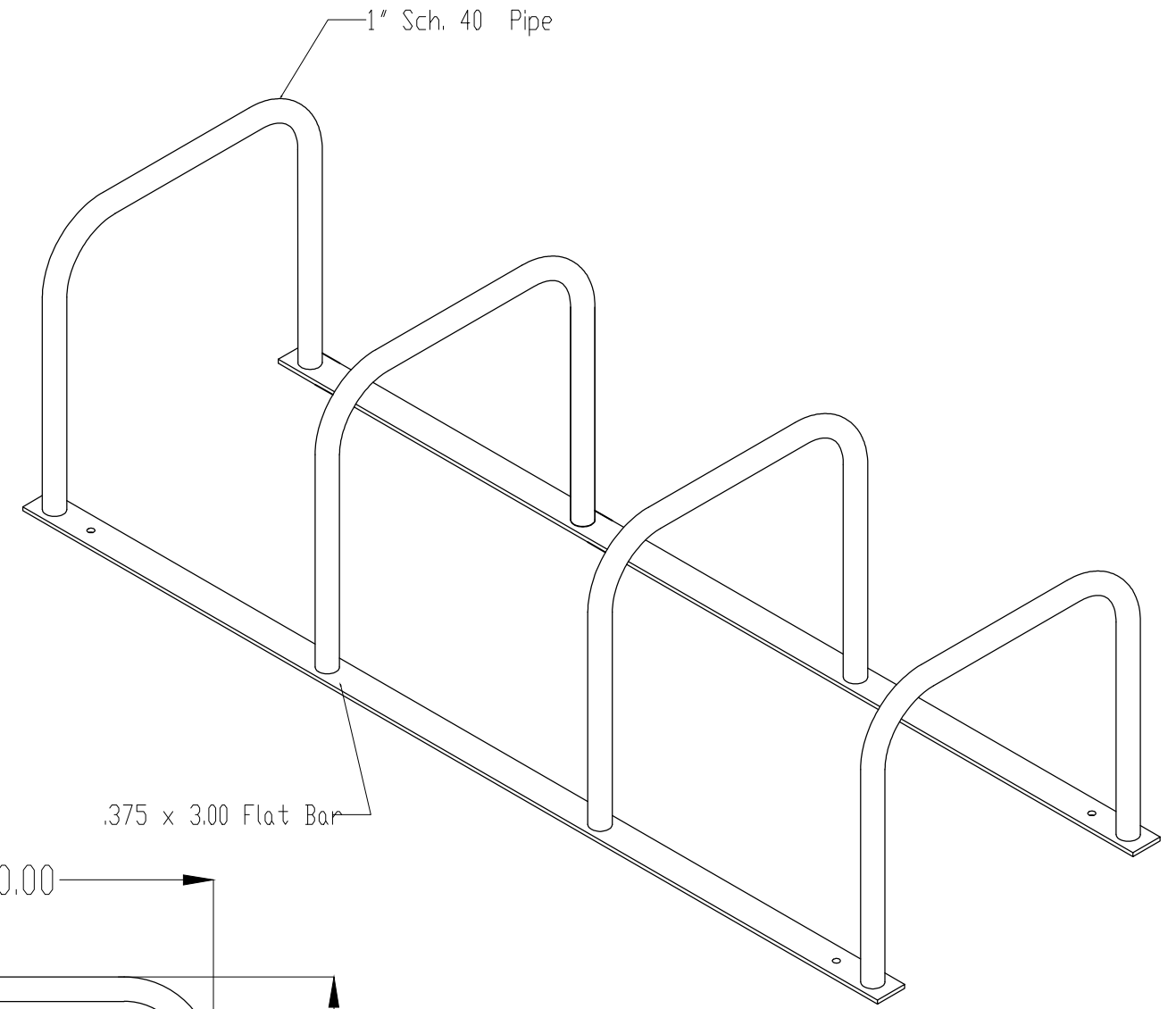
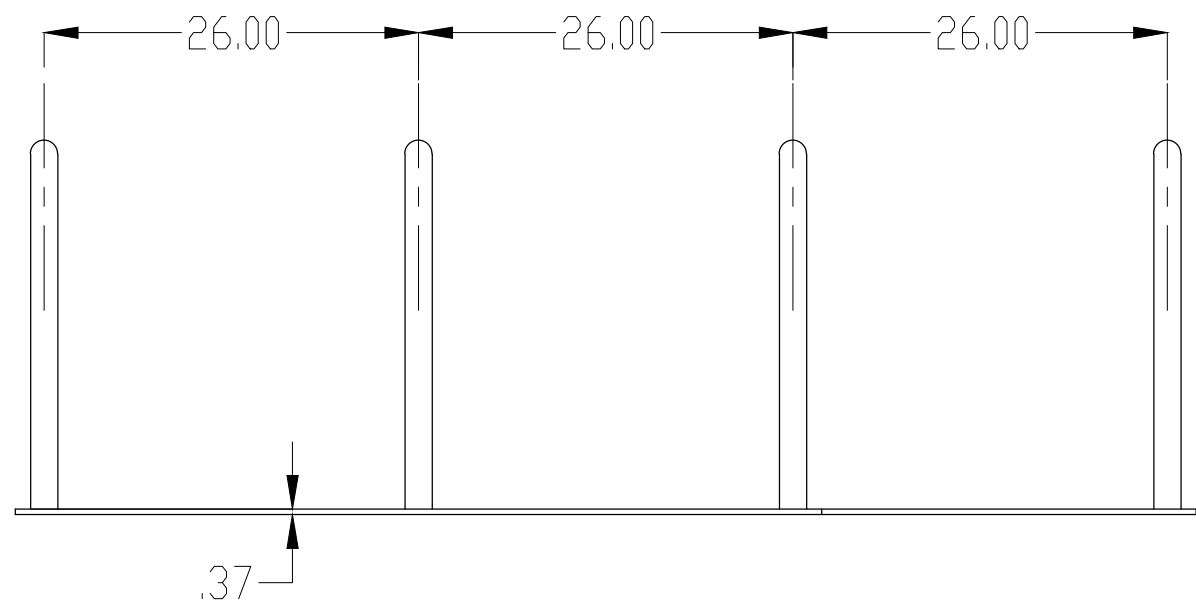
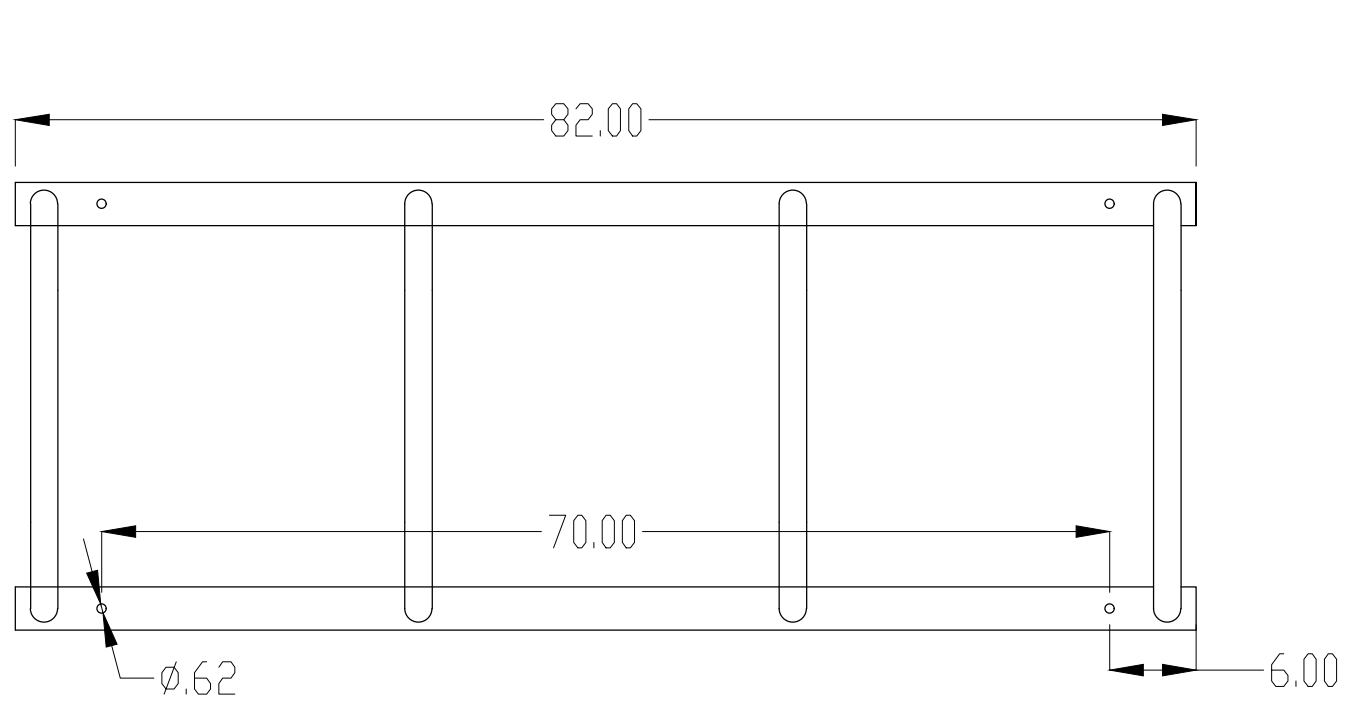

<p>ALL DIMENSIONS IN INCHES DO NOT SCALE THIS DRAWING</p>	
<p>EDMONTON BICYCLE COMMUTERS</p>	<p>EBC-STAPLE-8</p>

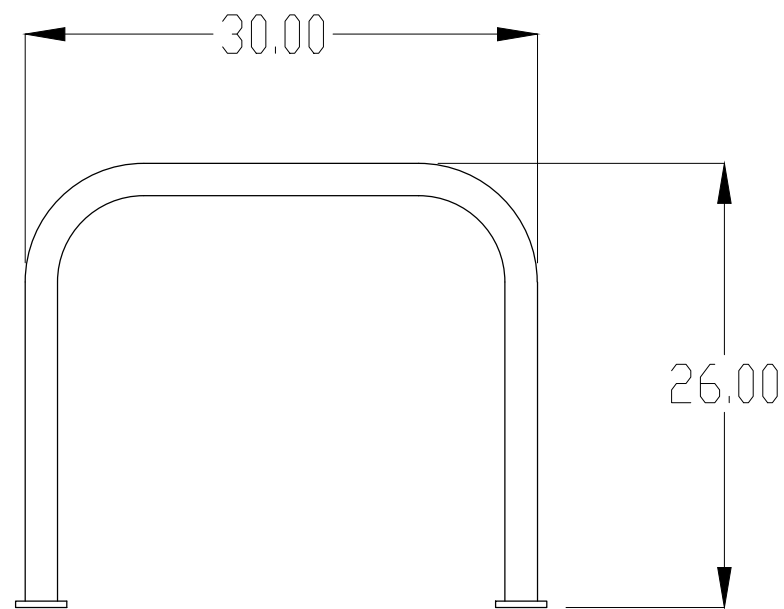
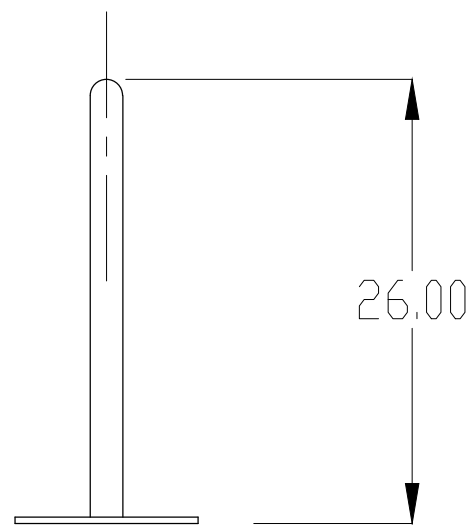
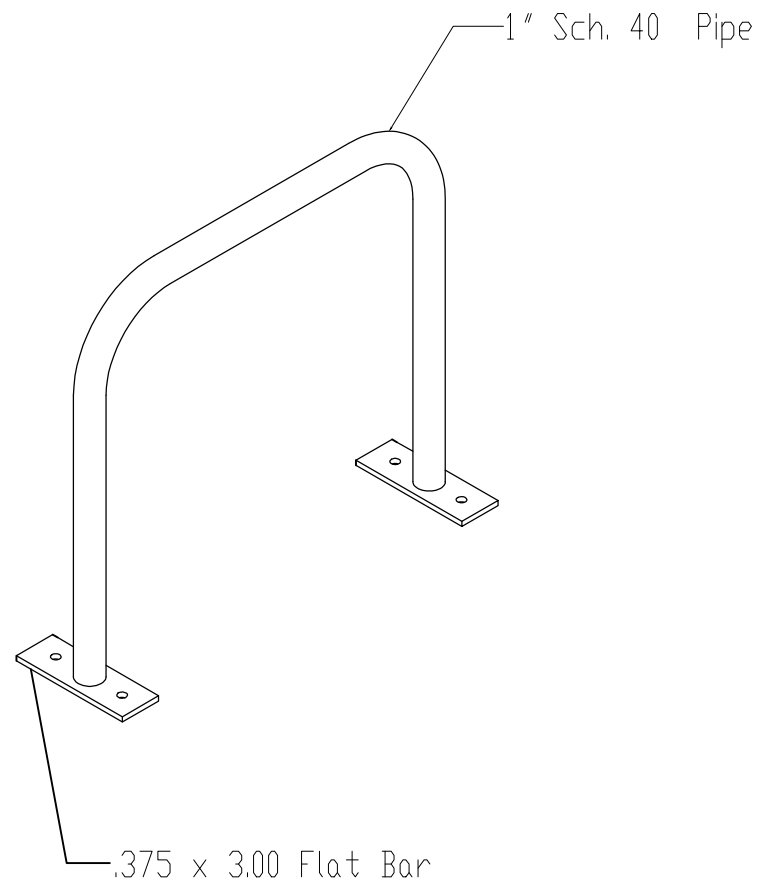
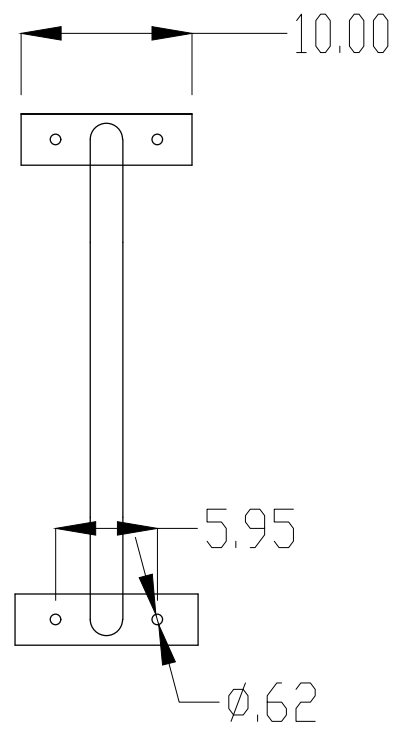

ALL DIMENSIONS IN INCHES
DO NOT SCALE THIS DRAWING

EDMONTON BICYCLE COMMUTERS

EBC-STAPLE-4

TIGER Drylac®

ral colors

exterior powder coatings



TIGER Drylac®
Powder Coatings

series 49

Weather Resistant TGIC Polyester Powder Coatings for Exterior and Interior Applications

Features: Good weather resistance, good mechanical properties, very smooth flow, good storage stability, good coverage

Gloss Level: All colors featured in this chart are available as standard products in smooth glossy with a gloss level of 80-90+ (gloss level according to Garner 60 deg., ASTM D 523).

Typical Applications: Residential windows and doors, garden equipment, patio furniture, automotive accessories, bicycles, motorcycles, sporting goods.

Standard Packaging: 55 lb boxes or 5 lb mini packs

Datasheets: Periodically updated datasheets, showing cure parameters, test results, pre-treatment information and more are available for all products in this chart. Please contact your local TIGER Drylac office or visit www.tigerdrylac.com for the most current edition.



All Series 49 (custom and stock) products, made in the US or Canada are periodically re-certified and carry the UL (Underwriter Laboratories) Recognized Component mark. This UL mark is for all equipment and products intended for the US and Canadian market.

series 38

Highly Weather- and UV-Resistant Powder Coatings based on Super Durable TGIC Polyester for Exterior and Interior Applications

Features: Superior gloss and color retention, excellent weather resistance, good mechanical properties, superior chalk resistance, smooth flow, excellent edge coverage, good storage stability. AAMA 2604-05 conforming.

Gloss Level: All colors featured in this chart are available as standard products in smooth glossy with a gloss level of 80-90 (gloss level according to Gardner 60 deg., ASTM D 523).

Typical Applications: Agricultural and construction equipment, bus shelters, lighting fixtures, playground equipment, site furnishings, garage doors, stadium seating, fencing, automotive equipment, and marine applications.

Standard Packaging: 44 lb boxes and 5 lb mini packs

Datasheets: Periodically updated datasheets, showing cure parameters, test results, pre-treatment information and more are available for all products in this chart. Please contact your local TIGER Drylac office or visit www.tigerdrylac.com for the most current edition.

RAL colors not available: Due to pigmentation a small percentage of colors in the yellow, orange, red and purple range offer only limited UV stability and are therefore not available.

More standard Series 38 products: For additional architectural mattes, glossy and metallic products please see our Series 38 Super Durable Powder Coatings brochure.

Custom colors: Custom colors not shown in this brochure can be custom made in 7 to 10 days. Due to pigmentation some colors in the yellow, orange, red and purple range offer only limited UV stability. UV stability of custom colors in that color range must be verified by our production laboratories on a case by case basis.

TIGER Drylac continues to offer the largest product selection in the powder coating industry. For additional standard products and innovative powder coating solutions please see our numerous other brochures including:

TIGER Drylac Metallic

TIGER Drylac Special Effect

TIGER Drylac Essentials

TIGER Drylac Specialties

TIGER Drylac Series 38 Super Durable

TIGER Drylac Anti-Graffiti

TIGER Drylac Series 58 Super Durable
(for approved applicators only)

TIGER Drylac Series 75 Fluoropolymer
(for approved applicators only)

TIGER Drylac Wood

Specifying TIGER Drylac products

In order to eliminate possible errors in specifying our products, we recommend using the full product number rather than specifying the RAL number only. This product number not only describes the Series/Chemistry, but also the exact color, finish and sheen.

Please check with your local TIGER Drylac office or representative for assistance with specifications and suitability issues.

RAL

Having gained worldwide acceptance over the last few decades, the RAL is the most popular Central European Color Standard used today.

The RAL colors in this chart have been matched as closely as possible. Color chart production methods and influence from heat and light may account for slight color deviation from the actual RAL Standard. This chart therefore can not serve as a standard for RAL color production and is to be used as a guide for color planning and specification only.

To aid in final product selection please contact your regional Tiger Drylac location for a powder coated Q-Panel of the product of your choice.

Product Code Matrix

































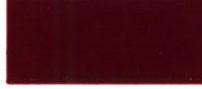







3 8 / 3 0 0 2 5















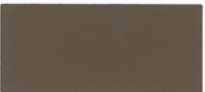











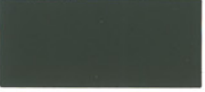

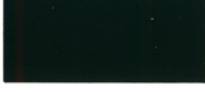

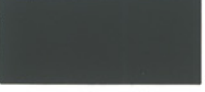











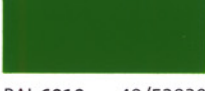
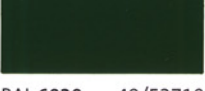
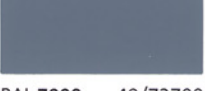
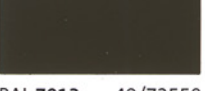

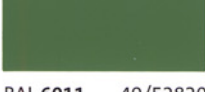

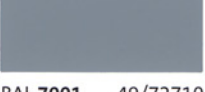
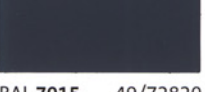
Chemistry

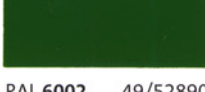
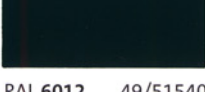
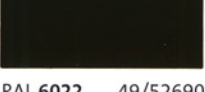
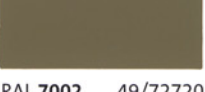
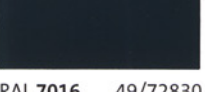
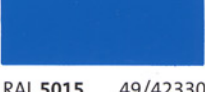
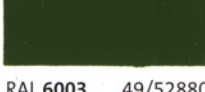
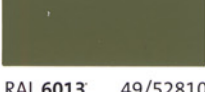
09 Polyester/Epoxy Hybrid
16 Acrylic Hybrid
28 Super Durable Polyester TGIC (for approved applicators only)
39 Polyester TGIC
44 Polyurethane
49 Polyester TGIC
59 Polyester TGIC-Free
69 Epoxy
75 Fluoropolymer (for approved applicators only)
89 Polyester/Epoxy Hybrid, Low/Fast Cure

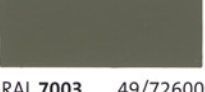
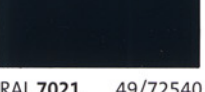
Color Group
(starting with)

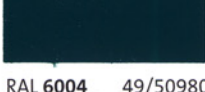
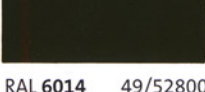
1 White
2 Yellow / Orange
3 Red
4 Blue
5 Green
6 Brown
7 Grey
8 Black
9 Metallic

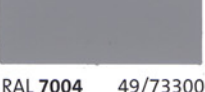
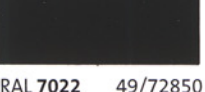
					
RAL 1000 49/15200 38/15000	RAL 1015 49/15320 38/15015	RAL 1033 49/22240	RAL 2012 49/24690	RAL 3014 49/31080	RAL 4004 49/31020 38/30024
					
RAL 1001 49/15190 38/15001	RAL 1016 49/22520 38/20016	RAL 1034 49/23910	RAL 3000 49/33120 38/30000	RAL 3015 49/33670	RAL 4005 49/42780
					
RAL 1002 49/22590 38/20002	RAL 1017 49/22510 38/20017	RAL 1037 49/20096	RAL 3001 49/31120 38/30001	RAL 3016 49/31980 38/30016	RAL 4006 49/32090
					
RAL 1003 49/22580	RAL 1018 49/21830 38/20018	RAL 2000 49/24570	RAL 3002 49/31110 38/30002	RAL 3017 49/31060	RAL 4007 49/32540 38/30025
					
RAL 1004 49/22570 38/20004	RAL 1019 49/13660 38/15019	RAL 2001 49/24560 38/23170	RAL 3003 49/31100 38/30003	RAL 3018 49/31050	RAL 4008 49/32280
					
RAL 1005 49/22560 38/20005	RAL 1020 49/22500 38/20020	RAL 2002 49/24550 38/25002	RAL 3004 49/33900 38/30004	RAL 3020 49/31040 38/30021	RAL 4009 49/34740
					
RAL 1006 49/22550 38/20006	RAL 1021 49/22280 38/20021	RAL 2003 49/24540	RAL 3005 49/31900 38/30005	RAL 3022 49/33700	RAL 4010 49/40490
					
RAL 1007 49/22540	RAL 1023 49/22490 38/20023	RAL 2004 49/24530	RAL 3007 49/31910 38/30007	RAL 3027 49/33660	RAL 5000 49/42200 38/40000
					
RAL 1011 49/15180 38/15011	RAL 1024 49/22480 38/20024	RAL 2008 49/24340	RAL 3009 49/31920 38/30009	RAL 3031 49/34730 38/30031	RAL 5001 49/42210 38/40001
					
RAL 1012 49/22530 38/20012	RAL 1027 49/22470 38/20027	RAL 2009 49/24360	RAL 3011 49/31090 38/30011	RAL 4001 49/43160	RAL 5002 49/42220 38/40002
					
RAL 1013 49/11280 38/10013	RAL 1028 49/22460	RAL 2010 49/24520 38/25001	RAL 3012 49/31940 38/30012	RAL 4002 49/31030 38/30008	RAL 5003 49/42230 38/40003
					
RAL 1014 49/15170 38/15014	RAL 1032 49/22450 38/20032	RAL 2011 49/24580	RAL 3013 49/31950 38/30013	RAL 4003 49/32270	RAL 5004 49/42240 38/40004

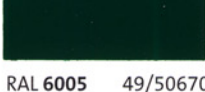
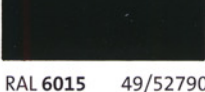
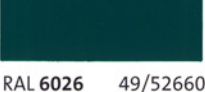
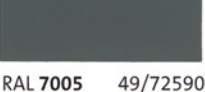
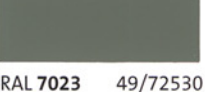
					
RAL 5005 49/43190 38/40010	RAL 5019 49/42360 38/40019	RAL 6006 49/52870 38/50006	RAL 6016 49/51020 38/50016	RAL 6027 49/50990 38/50027	RAL 7006 49/72580 38/70006
					
RAL 5007 49/42250 38/40007	RAL 5020 49/44270 38/40018	RAL 6007 49/52860 38/50007	RAL 6017 49/52780 38/50017	RAL 6028 49/52650 38/50028	RAL 7008 49/72570 38/70008
					
RAL 5008 49/42260 38/40008	RAL 5021 49/41190 38/40021	RAL 6008 49/53240 38/50008	RAL 6018 49/52720 38/50018	RAL 6029 49/52640 38/50029	RAL 7009 49/72770 38/70009
					
RAL 5009 49/42270 38/40009	RAL 5022 49/42390 38/40022	RAL 6009 49/52840 38/50009	RAL 6019 49/51000 38/50019	RAL 6032 49/52630 38/50032	RAL 7010 49/72560 38/70014
					
RAL 5010 49/42280 38/40016	RAL 5023 49/44650 38/40023			RAL 6033 49/55010 38/50033	RAL 7011 49/72790 38/70011
					
RAL 5011 49/43180 38/40011	RAL 5024 49/44660 38/40024	RAL 6034 49/55020 38/50034	RAL 7012 49/71180 38/70012		
					
RAL 5012 49/43170 38/40012	RAL 6000 49/53160 38/50000	RAL 6010 49/52830 38/50031	RAL 6020 49/52710 38/50020	RAL 7000 49/72700 38/70000	RAL 7013 49/72550 38/70013
					
RAL 5013 49/42310 38/40013	RAL 6001 49/52900 38/50005	RAL 6011 49/52820 38/50011	RAL 6021 49/52700 38/50021	RAL 7001 49/72710 38/70003	RAL 7015 49/72820 38/70015
					
RAL 5014 49/42320 38/40014	RAL 6002 49/52890 38/50023	RAL 6012 49/51540 38/50012	RAL 6022 49/52690 38/50022	RAL 7002 49/72720 38/70007	RAL 7016 49/72830 38/70016
					
RAL 5015 49/42330 38/40015	RAL 6003 49/52880 38/50003	RAL 6013 49/52810 38/50013	RAL 6024 49/52680 38/50024	RAL 7003 49/72600 38/70017	RAL 7021 49/72540 38/70021
					
RAL 5017 49/40760 38/40017	RAL 6004 49/50980 38/50004	RAL 6014 49/52800 38/50014	RAL 6025 49/52670 38/50025	RAL 7004 49/73300 38/70004	RAL 7022 49/72850 38/70022
					
RAL 5018 49/41140 38/40020	RAL 6005 49/50670 38/50002	RAL 6015 49/52790 38/50015	RAL 6026 49/52660 38/50026	RAL 7005 49/72590 38/70005	RAL 7023 49/72530 38/70023



RAL 7024 49/72870
38/70024



RAL 7040 49/75470
38/70046



RAL 8007 49/66120
38/60007

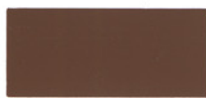

RAL 8025 49/66050
38/60025



RAL 7026 49/72880
38/70026



RAL 7042 49/73250
38/70042



RAL 8008 49/66110
38/60008



RAL 8028 49/66500
38/60028



RAL 7030 49/72890
38/70027



RAL 7043 49/72460
38/70043



RAL 8011 49/66100
38/60011



RAL 9001 49/10016
38/10001



RAL 7031 49/72520
38/70031



RAL 7044 49/75480
38/70044



RAL 8012 49/66090
38/60012



RAL 9002 49/70520
38/10002



RAL 7032 49/72910
38/70001



RAL 7045 49/77890
38/70045



RAL 8014 49/65230
38/60010



RAL 9003 49/11400
38/10003



RAL 7033 49/72510
38/70033



RAL 7046 49/72010
38/70002



RAL 8015 49/63040
38/60015



RAL 9004 49/81950
38/80004



RAL 7034 49/72500
38/70034



RAL 7047 49/72020
38/70047



RAL 8016 49/66080
38/60016



RAL 9005 49/82830
38/80010



RAL 7035 49/73510
38/70035



RAL 8000 49/66170
38/60000



RAL 8017 49/65220
38/60017



RAL 9010 49/11500
38/10004



RAL 7036 49/72950
38/70036



RAL 8001 49/66160
38/60005

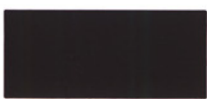

RAL 8019 49/65490
38/60019

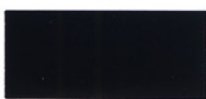

RAL 9011 49/80540
38/80001

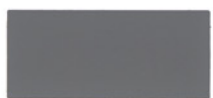

RAL 7037 49/72480
38/70037



RAL 8002 49/66150
38/60002

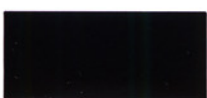

RAL 8022 49/63080
38/60022



RAL 9016 49/11340
38/10010



RAL 7038 49/72470
38/70038



RAL 8003 49/66140
38/60003



RAL 8023 49/66070
38/60023

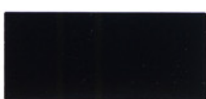

RAL 9017 49/80550
38/80017



RAL 7039 49/71020
38/70039



RAL 8004 49/66130
38/60004



RAL 8024 49/66060
38/60024



RAL 9018 49/72490
38/10018

exterior

EUROPE

AUSTRIA

TIGER Coatings GmbH & Co. KG
A-4600 Wels
phone +43 / (0)7242 / 400-0
fax +43 / (0)7242 / 650 08
office@tiger-coatings.com
www.tiger-coatings.com

BELGIUM

Mr. Eric Kun
B-3680 Maaseik
phone +32 / (0)497 / 41 57 97
fax +32 / (0)89 / 56 78 58
office.be@tiger-coatings.com

C&E Warehousing

B-3640 Kinrooi
phone +32 / (0)497 / 92 25 70
fax +32 / (0)89 / 56 78 58

BOSNIA & HERZEGOVINA

Klio d.o.o.
BiH-75300 Lukavac
phone +387 / 35 / 555 392
fax +387 / 35 / 553 256
office.bih@klio.hr

Klio 1
BiH-71210 Iliđža, Sarajevo
phone +387 / 33 / 626 621

BULGARIA

Deyacolor LTD
BG-1113 Sofia 13 post box no. 265
phone/fax +359 / 2 978 58 61
office@deyacolor.com

CROATIA

Klio d.o.o.
CRO-10360 Zagreb Sesvete
phone +385 / (0)1 / 200 90 41
fax +385 / (0)1 / 200 90 43
klio@klio.hr

CZECH REPUBLIC

TIGERLAK, s.r.o.
CZ-620 00 Brno
phone +420 / 545 429 110
fax +420 / 545 229 209
office.cz@tiger-coatings.com

DENMARK

Ms. Brigitte Pudor Gullev
DK-6200 Aabenraa
phone +45 / 73 62 13 23
mobil +45 / 21 20 45 20
fax +45 / 73 62 13 24
office.dk@tiger-coatings.com

FRANCE

TIGER S.A.R.L.
F-69480 Anse
phone +33 / (0)474 / 67 13 70
fax +33 / (0)474 / 67 10 42
office.fr@tiger-coatings.com

GERMANY

KLOZ Kunststofftechnik GmbH
D-70736 Fellbach-Oeffingen
phone +49 / (0)711 / 95 19 80 32
fax +49 / (0)711 / 518 07 50
info@kloz-kunststofftechnik.de

KLOZ Wickede
D-58739 Wickede-Ruhr
phone +49 / (0)2377 / 36 25
fax +49 / (0)2377 / 26 22

Jochen Hänel Handelsvertretung
D-65239 Hochheim a. M.-Süd
phone +49 / (0)6146 / 83 58 81
fax +49 / (0)6146 / 83 58 84
jhaenel@gmx.de

Boris Herrmann Handelsvertretung
D-44309 Dortmund
phone +49 / (0)231 / 25 70 12
fax +49 / (0)231 / 25 70 15
b.herrmann@tiger-coatings.com

Thomas Leitzke Handelsvertretung
D-47647 Kerken
phone +49 / (0)2833 / 57 39 32
fax +49 / (0)2833 / 57 39 33
t.leitzke@tiger-coatings.com

GREAT BRITAIN

TIGER COATINGS UK LTD
Solihull, West Midlands, B93 9EG
phone +44 / (0) 1564 778 866
fax +44 / (0) 1564 778 903
office.gb@tiger-coatings.com

HUNGARY

TIGERLAKK Kft.
H-1183 Budapest
phone +36 / 1 / 293 90 20
fax +36 / 1 / 297 45 49
office.hu@tiger-coatings.com

ITALY

TIGER Drylac Italia s.r.l.
I-24121 Bergamo
phone +39 / 035 / 417 39 67
fax +39 / 035 / 22 37 11
office.it@tiger-coatings.com

LITHUANIA, LATVIA

UAB „LAKMALIT“
LT-3000 Kaunas
phone +370 / 7 / 32 37 41, 32 34 95
fax +370 / 7 / 32 40 87
kaunas@lakmalit.lt

THE NETHERLANDS

Mr. Ben de Jong
NL-2133 GJ Hoofddorp
phone +31 / (0)6 / 419 956 80
fax +31 / (0)23 / 565 58 72
office.nl@tiger-coatings.com

POLAND

Tensor Consulting
PL-04512 Warszawa
phone +48 / (0)22 / 815 42 79
fax +48 / (0)22 / 815 42 79
ajelonek@tensor.com.pl

ROMANIA

SC TIGER Coatings Romania SRL
R-010631 Bucuresti
phone +40 / (0)21 / 314 77 37
fax +40 / (0)21 / 314 77 87
office.ro@tiger-coatings.com

RUSSIA

OOO TECHNOKOLOR-M
107370 Moscow, Russia
phone +007 / 495 / 966 75 08
fax +007 / 495 / 963 47 45
sales@technocolor.ru

SERBIA

Klio NS d.o.o.
SCG-21000 Novi Sad
phone +381 / 21 / 478 01 08
fax +381 / 21 / 641 00 40
office@klio.co.yu

SLOVAKIA

TIGERLAK Slovakia spol.s r.o.
SK-902 01 Pezinok
phone +421 / (0)33 / 640 00 71
fax +421 / (0)33 / 640 00 72
office.sk@tiger-coatings.com

SLOVENIA

T-Lotus d.o.o.
SLO-9240 Ljutomer
phone +386 / (0)2 / 583 18 79
fax +386 / (0)2 / 583 18 80
kontakt@t-lotus.si

SPAIN

TIGER Coatings GmbH & Co. KG
12001 Castellón - SPAIN
phone +34 / (0)664 / 328 449
fax +34 / (0)964 / 050 309
office.es@tiger-coatings.com

SWITZERLAND

FEYCO AG
CH-9430 St. Margrethen SG
phone +41 / (0)71 / 747 84 11
fax +41 / (0)71 / 747 85 10
info@feyco.ch

TURKEY

Enki İç ve Dis Tic. Paz. Dan. San. Tic. Ltd.Sti.
No: 26 Dk: 1Kadiköy-Istanbul
phone +90 / (0)216 / 467 38 57
fax +90 / (0)216 / 467 39 13
b.gurkan@tiger-coatings.com

UKRAINE

Interfarb - Ukraina
UA-79012 Lvov
phone/fax +380 / 322 / 40 23 11
phone/fax +380 / 322 / 97 10 76
interfarb@utel.net.ua

THE AMERICAS

ARGENTINA

Glass + Partner S.A.
AR-1429 Buenos Aires
phone +54 / 114 / 541 70 58
fax +54 / 114 / 541 70 58
glasspartner@arnet.com.ar

BRAZIL

TIGER Drylac do Brasil Ltda.
13295-000 ITUPEVA SP
phone +55 / 11 / 44 96 53 27
fax +55 / 11 / 44 96 65 14
office.br@tiger-coatings.com

CANADA

ONTARIO: TIGER Drylac Canada Inc.
Guelph, Ontario, N1G 4P5
phone +1 / 519 / 766 47 81
fax +1 / 519 / 766 47 87
info@tigerdrylaccanada.com

QUEBEC: TIGER Drylac Canada Inc.

Anjou, Quebec H1E 1P2
phone +1 / 514 / 351 53 31
fax +1 / 514 / 351 40 15
tigerqc@microtec.net

CALGARY: TIGER Drylac Canada Inc.

Calgary, Alberta Canada T2E 6L7
phone +1 / 403 / 398 97 23
fax +1 / 403 / 398 97 25
info@tigerdrylaccanada.com

VANCOUVER: TIGER Drylac Canada Inc.

Delta, BC V3M 5P8
phone +1 / 604 / 540 97 26
fax +1 / 604 / 540 97 25
vancouver@tigerdrylaccanada.com

CHILE

TIGER Drylac de Chile Ltda.
San Ramon, Santiago de Chile
phone +56 / 2 / 511 56 59
fax +56 / 2 / 511 56 59
office.cl@tiger-coatings.com

MEXICO

TIGER Drylac MEXICO S.A. DE C.V.
Col. Santa Cruz Acatlan, Naucalpan
Edo. de Mexico C.P. 53150
phone +52 / 555 / 363 12 14
fax +52 / 555 / 363 17 39
mexico@tigerdrylac.com

U.S.A.

TIGER Drylac U.S.A., Inc. (HQ's)
Ontario, CA 91761
phone +1 / 909 / 930 91 00
fax +1 / 909 / 930 91 11
customerservicewest@tigerdrylac.com

TIGER Drylac U.S.A., Inc.
St. Charles, IL 60174
phone +1 / 630 / 513 99 99
fax +1 / 630 / 513 99 98
customerservicemw@tigerdrylac.com

TIGER Drylac U.S.A., Inc. (HQ's)
Reading, PA 19605
phone +1 / 610 / 926 81 48
fax +1 / 610 / 926 81 49
customerserviceeast@tigerdrylac.com

TIGER Drylac U.S.A., Inc.
Kennesaw, GA 30144
phone +1 / 770 / 218 24 90
fax +1 / 770 / 218 24 95
customerservice@tigerdrylac.com

TIGER Drylac U.S.A., Inc.
Arlington TX 76011
phone +1 / 817 / 277 79 95
fax +1 / 817 / 277 19 31
customerservicesouth@tigerdrylac.com

MIDDLE EAST

UNITED ARAB EMIRATES

TIGER Coatings Middle East (FZE)
Sharjah
phone +971 / (0)6 / 559 06 23
fax +971 / (0)6 / 559 06 24
office.ae@tiger-coatings.com

ASIA

CHINA

TIGER Drylac (Taicang) Co. Ltd.
Taicang, Jiangsu 215400
P.R. China
phone +86 / (0)512 / 53 56 06 19
fax +86 / (0)512 / 53 95 50 95
office.cn@tiger-coatings.com

TIGER Drylac Beijing Warehouse
Shibali dian Chaoyang, Beijing
P.R. China
phone +86 / (0)10 / 87 30 44 38
fax +86 / (0)10 / 67 70 35 04

TIGER Drylac Guangzhou Warehouse
Nancun town, Panyu Guangzhou
P.R. China
phone +86 / (0)20 / 84 59 29 01
fax +86 / (0)20 / 34 57 94 97

HONG KONG

TIGER Coatings Hong Kong Limited
Kowloon, Hong Kong
phone +852 / 27 81 55 82
fax +852 / 27 82 58 86
office.hk@tiger-coatings.com

INDIA

National Corporation
Bangalore-560 002, INDIA
phone +91 / (0)80 / 222 265 54
fax +91 / (0)80 / 222 148 00
rsachdev@vsnl.com

JAPAN

TIGER Drylac JAPAN K.K.
Kanagawa, 229-1135, JAPAN
phone +81 / (0)42 / 760 60 56
fax +81 / (0)42 / 760 60 57
office.jp@tiger-coatings.com

MALAYSIA

TIGER Drylac MALAYSIA Sdn. Bhd.
50250, Kuala Lumpur
phone +60 / (0)3 / 20 39 43 15
fax +60 / (0)3 / 20 31 83 59
office.my@tiger-coatings.com

SINGAPORE

TIGER Drylac SINGAPORE Pte. Ltd.
SINGAPORE 759196
phone +65 / 67 59 94 33
fax +65 / 67 59 94 36
office.sg@tiger-coatings.com

TAIWAN

Vigorousport Int. Co., Ltd.
Taichung, TAIWAN
phone +886 / (0)4 / 23 82 21 23
fax +886 / (0)4 / 23 82 21 11
office.tw@tiger-coatings.com

THAILAND

Grand Siam Commercial Co., Ltd.
Bangkok 10320
phone +66 / 2 / 691 62 74
fax +66 / 2 / 691 22 25
apichart@samart.co.th

VIETNAM

TIGER Drylac Vietnam Co., Ltd.
Binh Duong Province
phone +84 / 650 / 758 370
fax +84 / 650 / 758 371
office.vn@tiger-coatings.com

TIGER Drylac Ha Noi Warehouse
Ha Noi
phone +84 / 4 / 762 81 65
fax +84 / 4 / 762 81 64



Member of the Powder Coating Institute and the U.S. Green Building Council